

Spray gun 1.7mm



Instructions for use
Translation of the original instructions



GENERAL SAFETY RULES

Warning:

Read this manual carefully and understand all the rules for safe use.

Failure to follow the instructions may result in damage to the equipment or injury.

After reading this manual, please keep and store it in an easily accessible place so that you can use it at any time while working with the equipment.

THE MEANING OF THE SYMBOLS:



Read and understand the operating instructions. It is the user's responsibility to follow the operating instructions and to instruct all users of the equipment on the principles of its use.



Warning! This symbol indicates important information about dangerous conditions, hazards or safety instructions.



Wear eye protection (goggles, mask).



Wear work gloves.



Wear a protective suit.



Use a respirator mask.

The spray gun is factory protected with an anti-corrosion agent. Before first use the gun

rinse with solvent.

Ensure that all elements of the equipment are correctly assembled, tightened and undamaged.

JOB:

- Keep the workplace clean and tidy. An untidy workplace can be the cause of an accident.
- Only use the device in well-ventilated rooms. Insufficient ventilation may be harmful to health, cause fire or explosion.
- Do not use the spray gun in rooms where paints and solvents are stored.
- Never store food in rooms where you use a spray gun.
- It is prohibited for persons without the required personal protective equipment to be in the spray gun work area.
- Do not use the gun near sources of ignition (open flame, lit cigarettes).
- Do not use the device in the presence of children and do not allow children access to the device.

SAFE USE

- The spray gun may only be used by a person who has read the instruction manual.
- The spray gun is powered by compressed air pressure.
- The supply air must be dry and clean.
- Do not use any other gas to power the device. This could damage the equipment and even cause a fire.
- Check hoses and couplings for leaks before starting work.
- Use only electrostatic discharge hoses.
- Never exceed the maximum operating pressure.
- Never cover the nozzle outlet holes.
- Do not leave the assembled air system unattended. Keep children away from the air system.
- High compressed air pressure can cause the gun to recoil in the opposite direction to the spray direction. Be especially careful as recoil can cause injury.
- Disconnect the compressed air hose before starting any maintenance work.
- Do not point a gun at yourself, other people, or animals.
- Do not direct the spray stream in the direction of ignition sources and open flames.
- Do not eat or smoke while working.
- Wear appropriate body protection: goggles, masks, gloves, coveralls.
- Before starting work, check the operation of the gun.
- Follow the paint manufacturer's recommendations and use in accordance with the personal protection, fire and environmental guidelines listed above.
- Harmful dust and fumes may be released during spraying. If you do not feel well, stop work. Always wear a painting mask with a suitable filter.
- In case of eye or skin irritation, contact a doctor. Always wear protective painting suit, work gloves and eye protection.
- If the equipment does not work or is mechanically damaged, stop work immediately and contact service.
- Do not modify the gun.

DESCRIPTION

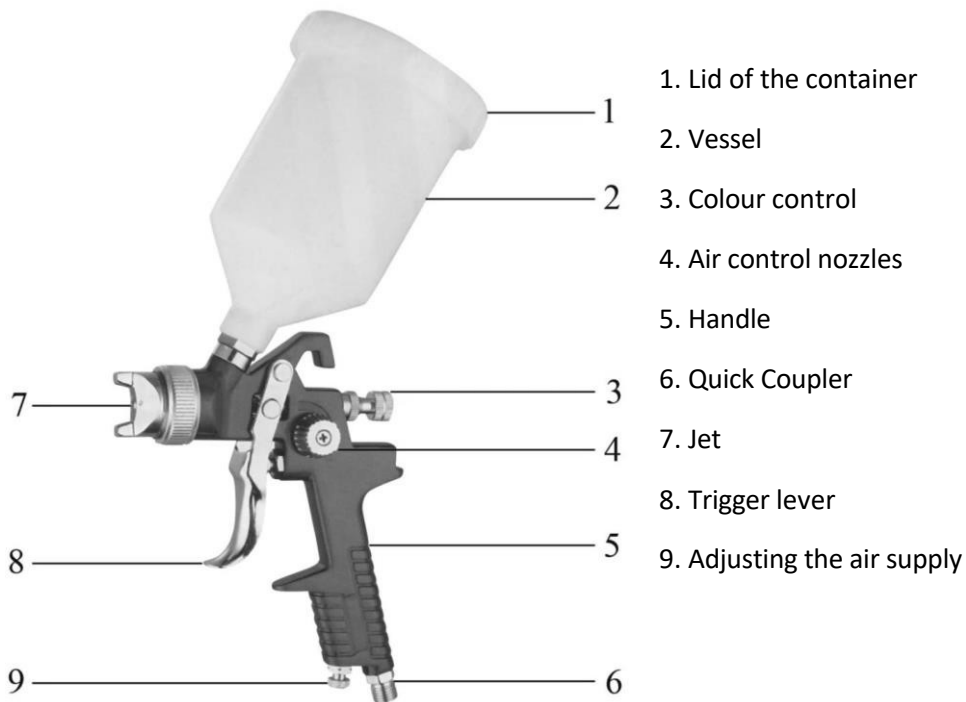

SERVICE

- Make sure that the gun is not contaminated with residues from previous painting.
- Pour the material you want to apply into the tank.
- Screw on the cap.
- Connect the compressed air hose to the gun.
- Perform a test spray by pulling the trigger.
- Adjust the flow and amount of paint to be applied.

By turning the top knob (3) you can adjust the amount of material to be applied. Too small an amount will result in inadequate coverage, while too large an amount may cause run-off.

The side knob (4) can be used to adjust the fine air control.

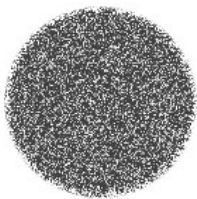

Round

- for small areas
and hard-to-reach places

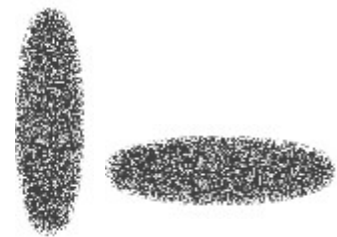

jetWide jet

- for application on larger areas

By turning the nozzle (7) you can adjust the wide jet horizontally or vertically.

The lower knob (9) is used for coarse control of the amount of supply air.

Hold the spray gun vertically, perpendicular to the painted surface while applying the material. Do not tilt the gun.

Make smooth, not too fast movements, parallel to the painted object. The distance of the nozzle from the surface should be between 15 and 25 cm.

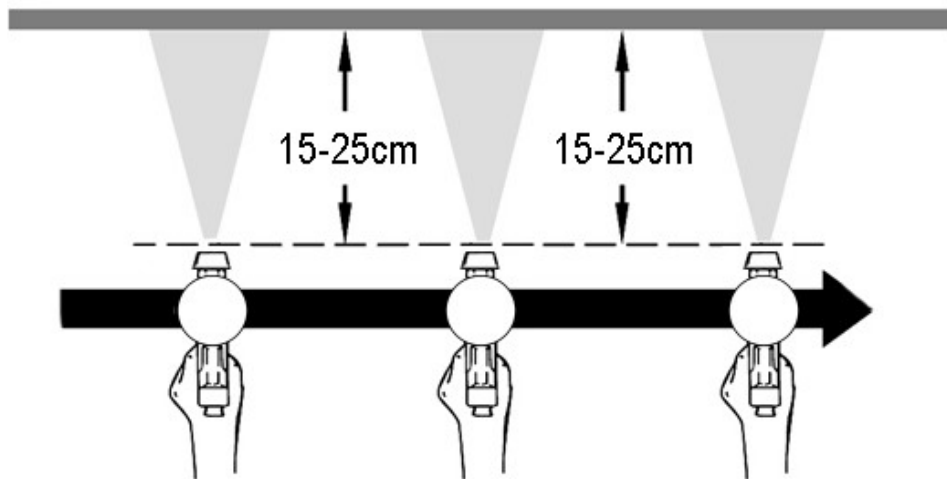

The correct way to apply paint.

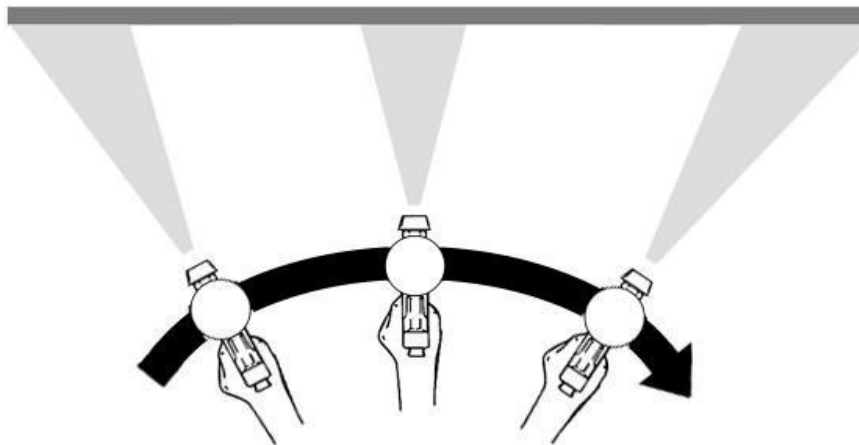

Incorrect method of paint application.

MAINTENANCE AND STORAGE

Perform all maintenance work with the tank empty and the compressed air pressure disconnected.

Always empty the tank completely when work is completed and then flush the gun with detergent.

Do not leave paint in the tank or leave the gun dirty. Dried paint can lead to equipment damage.

To prolong the trouble-free service life, the gun needs to be cleaned regularly.

Cleaning the gun:

- Disconnect the power supply.
- Empty and unscrew the paint container.
- Unscrew the nozzle.
- Unscrew the knob to control the amount of paint, remove the spring.
- Pull the trigger, gently pull the needle.
- Unscrew the nozzle with a spanner.
- Clean the inside of the gun with a solvent brush.
- Wash the needle and nozzle in solvent.
- Clean the spray gun and paint tank with a solvent cloth.
- Reassemble the device.

Do not use hard brushes and sandpaper. Never immerse the entire gun in solvent. This could damage the gasket. Once assembled, store the gun in a place protected from moisture and dust. Ensure that children do not have access to the device.

TECHNICAL DATA

Operating pressure approx.: 2.0 - 3.5

bar Air consumption: 45 - 113 l/min

Compressed air connection: ¼" Tank

capacity: 600 ml

Nozzle diameter: 1.7 mm



ENVIRONMENTAL PROTECTION

Do not pour paint or varnish down drains or other places not intended for that purpose. Dispose of leftover materials and used equipment in accordance with local environmental regulations.

Warranty conditions

In accordance with Act No. 136/2002 Coll., the product purchased by you is guaranteed for a period of 24 months from the date of sale. In the case of purchase of goods used for commercial or business activity, the warranty period is 12 months. The warranty is only provided if the products are used in accordance with the operating instructions and method of use.

All parts subject to natural wear and tear, overloading, use of the product for purposes other than those for which it is intended and defects caused by transport or improper (non-professional) handling are excluded from the warranty. We consider improper handling to be an example where the operating instructions and the generally binding regulations for handling the product have not been observed. Similarly, an attempt at unprofessional repair beyond the recommended maintenance is also assessed.

The warranty applies exclusively to defects caused by defects in materials, manufacturing assembly or processing technology.

The right to invoke the guarantee shall be extinguished:

- 1) the product has not been used in accordance with the operating instructions
- 2) any intervention has been made in the design of the machine without the prior written consent of the manufacturer
- 3) the product has been used in other conditions or for purposes other than those for which it is intended
- 4) a part of the product has been replaced by a non-original part
- 5) damage to the product or excessive wear and tear is caused by inadequate maintenance
- 6) damage caused by external mechanical, thermal or chemical influences
- 7) the defects were caused by improper storage or handling of the product
- 8) the product has been used (for the product type) in an aggressive environment e.g. dusty, humid
- 9) the product has been used in excess of the permissible load

The warranty does not cover items that can be expected to wear due to their normal function (e.g. wear on carbons, spark plug, etc.)

Use only recommended accessories and original spare parts to operate the products.

Claims should be made immediately upon discovery of the defect with the dealer who sold you the product and enquire about repair options at an authorised repairer. If the defect you are claiming is not covered by the warranty, you will be invoiced for the work and costs associated with the inspection and assembly and disassembly components.

When making claims, submit a properly completed warranty card or other proof of purchase bearing the date of sale.

Hand in the product for repair in a clean condition, properly cleaned, free of dust or dirt. Send the original accessories with the product for an accurate diagnosis of the fault.

When sending by transport service, pour out the unconsumed fuel and oil from the product. Pack the product properly, preferably in the original packaging, so as not to damage it. Damage caused by inadequate packaging cannot be accepted as a warranty defect!

Only use fuels and oils of the appropriate classification in the engines, or fuels and oils recommended by the branded dealer. Damage caused by the use of unsuitable fuels and oils will not be covered under warranty.